

TIPO I  
(SE REQUEREN 2)

ELEVACION LATERAL

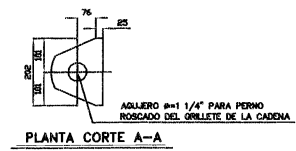

PLANTA CORTE A-A

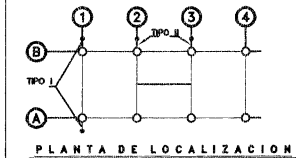

PLANTA DE LOCALIZACION

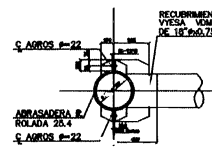

PLANTA CORTE B-B

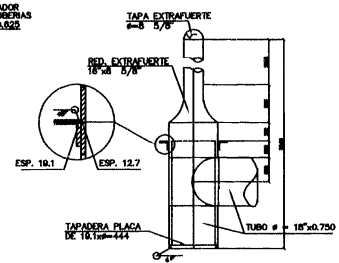

D-4 GUIA DE ACOPLAMIENTO

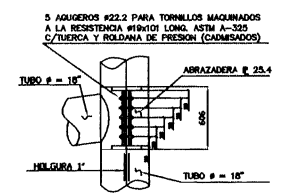

D-2 ELEVACION TUBO 18"

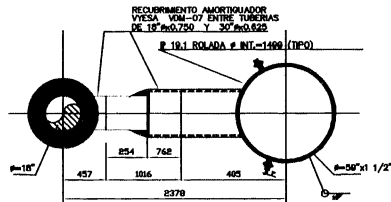

PLANTA CORTE B-B

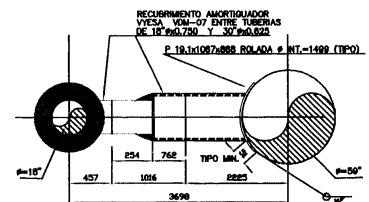

PLANTA CORTE A-A

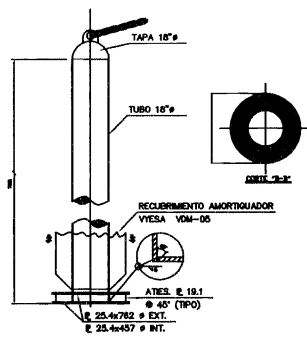

DETALLE 3.- CAMISA DE RECURRIMIENTO VIESA VDM-05

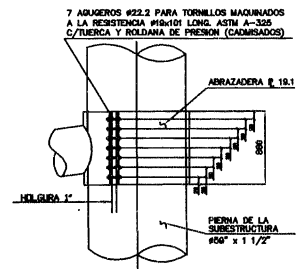

DETALLE 5.- ELEVACION DE ABRAZADERA

**COMPAÑIA HULERA VIESA**  
**VULCANIZACIONES Y EQUIPOS S.A.**  
 TEL. (01044) 8-33-10-02 8-33-14-44 8-33-18-08 8-33-23-03-09  
 CARRETERA 07 KM. 10885 APO. SAN VICENTE COSTA RICA

DEFENSA MARINA (V.D.M. - 05)  
 DISEÑO: A.F.A. / REVISÓ: D.L.A. / FECHA: 12-02-2004 / NÚMERO ALER. / IMPRESO: A.L.  
 ESCR.: S/CDIC. / ACC.: mm. / DR. No. VIESA/MVA/VDM-05/001 / REV. 0